

产品名称: _____

产品型号: _____

客户名称: _____

购买日期: _____

出厂编码: _____

维修记录

保修日期	故障及检测情况说明	维修日期	维修员

PRODUCT NAME: _____

PRODUCT MODEL: _____

NAME OF CLIENT: _____

DATE OF PURCHASE: _____

FACTORY CODE: _____

Maintenance record list

DATE IN SERVICE	EQUIPMENT MAINTENANCE DETAIL	MAINTENANCE DATE	MAINTENANCE PERFORMED BY

保修说明

- 如下情况属于保修范围,可免费维修:
 - 机器质保期为12个月,电源适配器、电脑数据线质保期为12个月。
 - 在质保期内,非人为损坏,免费维修。
 - 质保范围是指产品在正常使用下出现问题。备注:外观问题不属于保修范围。
- 如下情形非保修范围,如需提供维修服务,可酌情收取物料及服务费用:
 - 退换货、送修途中由于运输、装卸所导致的损坏。
 - 任何未经授权许可的改装、拆卸、维修。
 - 意外因素或人为行为导致产品损坏。如:进液、摔损、输入不合电压、过度挤压、主板变形等。对于电源适配器,若有明显的硬物损伤、裂痕、断脚、严重变形,电线破损、断线、裸芯等现象。
 - 未按使用说明书要求安装、使用、维护、保管导致的产品故障或损坏。
 - 保修凭证与产品型号不符或保修凭证被涂改。
 - 产品铭牌、SN条码、防拆标签被撕掉或被损坏,模糊不清无法识别。
 - 已经超出保修期限。
 - 由于不可抗因素(如火灾、地震、水灾等)而造成的故障或损坏。
- 凭保修卡保修。

送修服务指引

- 送修前,请您提前备份个人数据。维修过程中可能会造成您个人数据的丢失,我们会保护您的个人隐私,但不承担维修过程中个人数据损坏、丢失的责任。
- 送修时,产品须经过授权服务中心专业的检测。确认故障后,服务中心会确定相应的维修方案。对于检测无故障产品,将原样退回。
- 因产品不符合保修条件需收取费用的,授权服务中心将向消费者收取维修费。

PRODUCT WARRANTY

- The following are covered by the warranty and can be repaired free of charge:
 - (1) From the purchase date, 12 months warranty period supply for machine, power adapter and data cable.
 - (2) In the case of any malfunction/ breakage/ damage that occurs under normal conditions (Non-human damage) within the warranty period, repair will be performed by free.
 - (3) The warranty covers problems with the product under normal use. Note: cosmetic issues are not covered by the warranty.
- The following conditions are not covered under the terms of the warranty. If maintenance services are required, material and service fees may be charged as appropriate:
 - (1) Damage caused by transportation, loading and unloading during return, exchange, and repair.
 - (2) Any unauthorized modification, disassembly and repair.
 - (3) Damage caused by accidental factors or human actions. Such as: liquid ingress, drop damage, input inappropriate voltage, excessive extrusion, motherboard deformation, etc. For the power adapter, if there are obvious hard object damage, cracks, broken feet, severe deformation, damaged wires, broken wires, bare cores, etc.
 - (4) Product damage caused by failure to install, use, maintain, and store in accordance with the user manual.
 - (5) The warranty certificate does not match the product model or has been altered.
 - (6) The product nameplate, SN barcode, and tamper-proof label are torn off or damaged, making them blurred and unrecognizable.
 - (7) The product is out of warranty.
 - (8) Failure or damage caused by irresistible factors (such as fire, earthquake, flood, etc.).

Repair Service Guide

- Before sending for repair, please back up your personal data in advance. Your personal data may be lost during the maintenance process. We will protect your personal privacy, but we will not be responsible for the damage or loss of personal data during the maintenance process.
- When sending for repair, the product must be professionally inspected by an authorized service center. After confirming the fault, the service center will determine the corresponding maintenance plan. For detected non-faulty products, it will be returned as is.
- If a fee is charged because the product does not meet the warranty conditions, the authorized service center will charge the consumer for maintenance.

合格证书

深圳市亿道信息股份有限公司
 电话: 400-830-4882
 地址: 深圳市坪山区坑梓街道金沙社区光辉路1号超捷工业园厂房C栋401
 邮编: 518122
 邮箱: support@onerugged.com

设备形态: 工业平板电脑

设备型号: P15J

序列号: _____

质保期: _____



*本页内容不得擅自涂改,并请保存产品包装盒,以维护您的合法权益。

合格证书

Shenzhen Emdoor Information Co., Ltd.
 Telephone: 400-830-4882
 Address: Room 401, Building C, Chaojie Industrial Park, No. 1 Guanghui Road, Jinsha Community, Kengzi Street, Pingshan District, Shenzhen, China
 Post code: 518122
 Mail: support@onerugged.com

EQUIPMENT FORM: Panel PC

DEVICE MODEL: P15J

SERIAL NUMBER: _____

WARRANTY: _____



*The contents of this page shall not be altered without authorization, and please keep the product packaging box to protect your legal rights.

本章首先教导您如何将设备准备好,以便让您开始工作。接着概略地介绍设备的外观和组件。This chapter first tells you step by step how to get the computer up and running. Then, you will find a section briefly introducing the external components of the computer.

开箱检查/OPEN BOX TO CHECK

- 打开包装后,您应该会看到下列标准项目:
- P15J 工业平板电脑 · 电源线 · 电源适配器
- After unpacking, you should see the following standard items:
- P15J Panel PC Terminal · Power Cord · Power Adapter

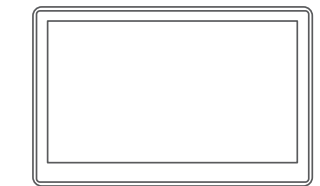

注意: 仅限使用本产品随附的电源适配器。使用其他电源适配器可能会损坏您的设备。第一次开机时必须连接 AC 电源。Note: Use only the power adapter provided with this product. Using other power adapters may damage your device. It must be connected to the AC power supply when it is turned on for the first time.

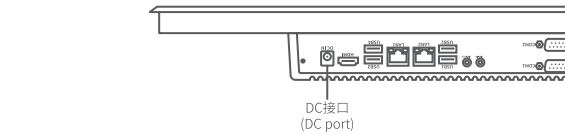

- 电源适配器的 DC 头 插入设备的 DC 口内。
- 将电源线的母端口插入电源适配器,公端口插入电源插座。
- 电源插座通过适配器为设备供电。现在您可以打开设备电源。

设备开机和关机/TURNING ON AND OFF THE DEVICE

开机/START UP

- 接上电源后工控机将自动开机。无需手动按下开机按键,操作系统 Microsoft Windows 将启动。1. After the power is connected, the Industrial Panel PC will start automatically. The operating system Microsoft Windows will start without manually pressing the power on button.

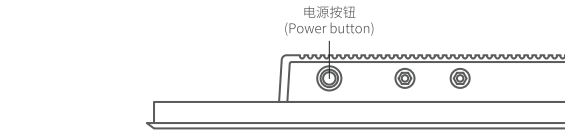

关机/SHUTDOWN

在完成工作之后，您可以关闭电源或者让设备进入睡眠或休眠状态：

When you're work done, you can power it off or leaving it in Sleep or Hibernation mode:

要/TO...	方法/DO THIS..
关闭电源 (shut down)	单机 → [电源] → [关机]/Click → [电源] → [Shutdown]
睡眠 (Sleep)	使用下述任一方法： 1. 单机 → [电源] → [睡眠]/Click → [电源] → [Sleep]. 2. 按电源键/Press the power button.
休眠 (Hibernate)	在默认状态下，此项并不会出现在 [电源] 菜单里。如果您想要使用此功能，请到 Windows 的设置处进行设置。 /By default, this option is not shown in the Start menu. If you want to use the feature, set up accordingly in Windows settings.

设备外观介绍/EQUIPMENT APPEARANCE INTRODUCTION

注：1. 依照所购买的型号不同，设备外观可能和本手册所显示的结构有所不同。

Note: 1. Depending on the special model you purchased, the look of the device may be different from the the graphics shown in this manual.

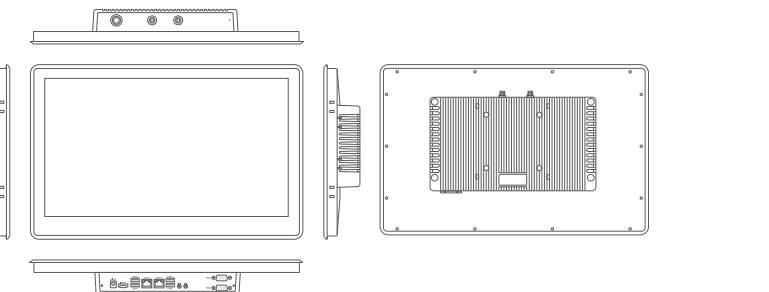

正面组件/Front COMPONENTS

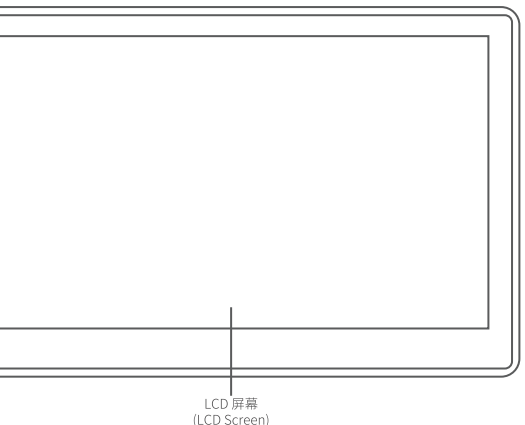

LCD 屏幕
(LCD Screen)

背面组件//REAR COMPONENTS

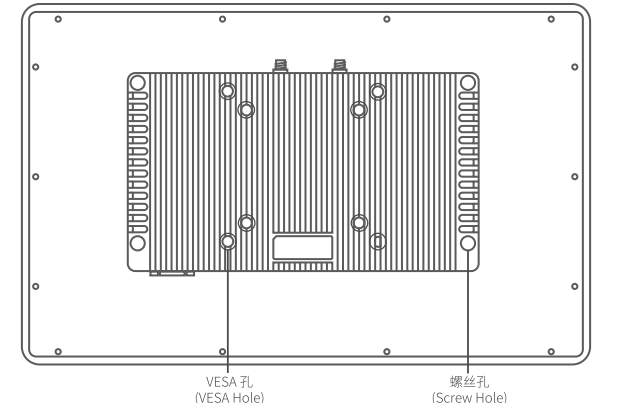

VESA 孔：用于配合 VESA 支架固定工控机。
注：出货不提供 VESA 支架，需要自行购买。
 VESA 孔规格：直径 3.5mm，内孔距离 75mm，外孔距离 100mm。
 VESA Hole: Used to fix the industrial computer with VESA bracket.
Note: VESA bracket is not provided for shipment, and you need to purchase it yourself.
 VESA Hole Specification: Diameter 3.5mm, Inner hole distance 75mm, Outer hole distance 100mm

左侧和右侧组件/LEFT AND RIGHT SIDE COMPONENTS

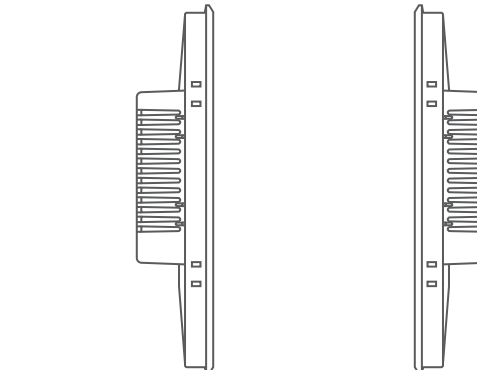

顶部组件/TOP COMPONENTS

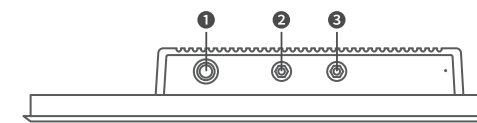

符号 (SYMBOL)	组件 (COMPONENTS)	说明 (DESCRIPTION)
1	物理开机按键 (标配) /Power Button (Standard)	突发情况时可用物理按键开关设备 /Physical key switch device can be used in case of emergency.

底部组件/BOTTOM COMPONENTS

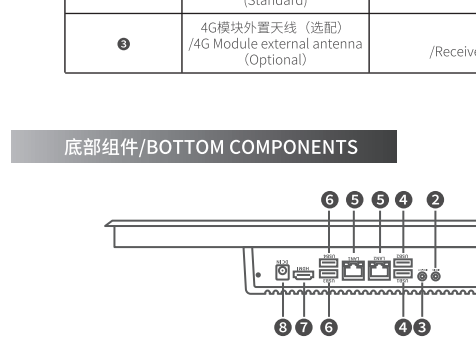

符号 (SYMBOL)	组件 (COMPONENTS)	说明 (DESCRIPTION)
1	RS232串口/RS232 Serial Port	使不同的设备可以方便地连接起来进行通讯 /Make it easy to connect different devices for communication.
2	LINE-IN	音频输入/Audio input.
3	LINE-OUT	音频输出/Audio output.
4	USB2.0接口/USB2.0 Port	用于传输数据/Used to transfer data.

背面组件//REAR COMPONENTS

2	WiFi/BT外置天线 (标配) /WiFi/BT external antenna (Standard)	连接WiFi线束，接收WiFi信号 /Connect WiFi harness and receive WiFi signal.
3	4G模块外置天线 (选配) /4G Module external antenna (Optional)	接收SIM卡信号及网络 /Receive SIM card signal and network.

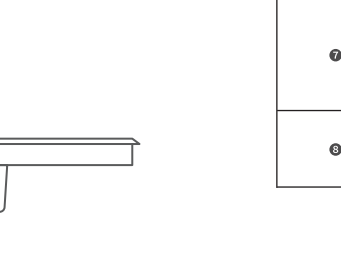

符号 (SYMBOL)	组件 (COMPONENTS)	说明 (DESCRIPTION)
5	RJ45网口/RJ45 Internet Port	10/100/1000M 自适应 / 10/100/1000M adaptive.
6	USB3.0接口/USB3.0 Port	用于传输数据/Used to transfer data
7	HDMI接口/HDMI Connector	发送未压缩的音频及视频信号；高清多媒体接口 HDMI 是一种全数字化视频和声音发送接口。 /Sending uncompressed audio and video signals. HDMI is a full digital video and sound transmission interface.
8	DC接口/DC Power Jack	宽压设计，支持12V、19V、24V、36V电压输入 /Wide voltage design, supporting 12V, 19V, 24V, 36V voltage input.

电源适配器/POWER ADAPTER

5	RJ45网口/RJ45 Internet Port	10/100/1000M 自适应 / 10/100/1000M adaptive.
6	USB3.0接口/USB3.0 Port	用于传输数据/Used to transfer data
7	HDMI接口/HDMI Connector	发送未压缩的音频及视频信号；高清多媒体接口 HDMI 是一种全数字化视频和声音发送接口。 /Sending uncompressed audio and video signals. HDMI is a full digital video and sound transmission interface.
8	DC接口/DC Power Jack	宽压设计，支持12V、19V、24V、36V电压输入 /Wide voltage design, supporting 12V, 19V, 24V, 36V voltage input.

注意：
 · 电源适配器仅供您的工控机使用。若挪作其它用途将可能损坏接上的电器或者适配器。
 · 电源适配器所附的电源线为符合购买地的规格。若要在国外使用此工控机，请咨询经销商取得合适的电源线。
 · 若欲拨开电源适配器时，必须先拔掉墙壁上的电源插头，再拔掉插在工控机上的电源接头，否则会便工控机及适配器受到外部电压冲击而受损。
 · 拔掉插头时，请垂直 90° 插拔，切勿拉扯电线，应用手握着插头拔出。

Notice:
 · The AC adapter is designed for use with your Industrial Panel PC only. Connecting the AC adapter to another device can damage the adapter.
 · The AC power cord supplied with your Industrial Panel PC is for use in the country where you purchased your Industrial Panel PC. If you plan to go overseas with the Industrial Panel PC, consult your dealer for the appropriate power cord.
 · When you disconnect the AC adapter, disconnect from the electrical outlet first and then from the Industrial Panel PC. A reverse procedure may damage the AC adapter or Industrial Panel PC.
 · When unplugging the connector, please plug in 90° vertically, always hold the plug head. Never pull on the cord.

由于您的工控机是以直流电运作，但是电源插座通常是提供交流电源，因此电源适配器的作用就是将供电来源的交流电转换为工控机所需的直流电。
 适配器可在 100V 至 240V AC 的电压范围内运作。
 The AC adapter serves as a converter from AC (Alternating Current) to DC (Direct Current) power because your Industrial Panel PC runs on DC power, but an electrical outlet usually provides AC power. It also charges the battery pack when connected to AC power.
 The adapter operates on any voltage in the range of 100-240V AC.

故障排除/TROUBLESHOOTING

设备问题可以是硬件、软件、或两者共同引起的。当您遇到问题时，它可能只是一个一般性问题，能够轻易就解决。
 本章告诉您在面临一般性问题时，该尝试什么方法来解决。

电源适配器/POWER ADAPTER

5	RJ45网口/RJ45 Internet Port	10/100/1000M 自适应 / 10/100/1000M adaptive.
6	USB3.0接口/USB3.0 Port	用于传输数据/Used to transfer data
7	HDMI接口/HDMI Connector	发送未压缩的音频及视频信号；高清多媒体接口 HDMI 是一种全数字化视频和声音发送接口。 /Sending uncompressed audio and video signals. HDMI is a full digital video and sound transmission interface.
8	DC接口/DC Power Jack	宽压设计，支持12V、19V、24V、36V电压输入 /Wide voltage design, supporting 12V, 19V, 24V, 36V voltage input.

注意：
 · 电源适配器仅供您的工控机使用。若挪作其它用途将可能损坏接上的电器或者适配器。
 · 电源适配器所附的电源线为符合购买地的规格。若要在国外使用此工控机，请咨询经销商取得合适的电源线。
 · 若欲拨开电源适配器时，必须先拔掉墙壁上的电源插头，再拔掉插在工控机上的电源接头，否则会便工控机及适配器受到外部电压冲击而受损。
 · 拔掉插头时，请垂直 90° 插拔，切勿拉扯电线，应用手握着插头拔出。

Notice:
 · The AC adapter is designed for use with your Industrial Panel PC only. Connecting the AC adapter to another device can damage the adapter.
 · The AC power cord supplied with your Industrial Panel PC is for use in the country where you purchased your Industrial Panel PC. If you plan to go overseas with the Industrial Panel PC, consult your dealer for the appropriate power cord.
 · When you disconnect the AC adapter, disconnect from the electrical outlet first and then from the Industrial Panel PC. A reverse procedure may damage the AC adapter or Industrial Panel PC.
 · When unplugging the connector, please plug in 90° vertically, always hold the plug head. Never pull on the cord.

由于您的工控机是以直流电运作，但是电源插座通常是提供交流电源，因此电源适配器的作用就是将供电来源的交流电转换为工控机所需的直流电。
 适配器可在 100V 至 240V AC 的电压范围内运作。
 The AC adapter serves as a converter from AC (Alternating Current) to DC (Direct Current) power because your Industrial Panel PC runs on DC power, but an electrical outlet usually provides AC power. It also charges the battery pack when connected to AC power.
 The adapter operates on any voltage in the range of 100-240V AC.

故障排除/TROUBLESHOOTING

设备问题可以是硬件、软件、或两者共同引起的。当您遇到问题时，它可能只是一个一般性问题，能够轻易就解决。
 本章告诉您在面临一般性问题时，该尝试什么方法来解决。

电源适配器/POWER ADAPTER

5	RJ45网口/RJ45 Internet Port	10/100/1000M 自适应 / 10/100/1000M adaptive.
6	USB3.0接口/USB3.0 Port	用于传输数据/Used to transfer data
7	HDMI接口/HDMI Connector	发送未压缩的音频及视频信号；高清多媒体接口 HDMI 是一种全数字化视频和声音发送接口。 /Sending uncompressed audio and video signals. HDMI is a full digital video and sound transmission interface.
8	DC接口/DC Power Jack	宽压设计，支持12V、19V、24V、36V电压输入 /Wide voltage design, supporting 12V, 19V, 24V, 36V voltage input.

注意：
 · 电源适配器仅供您的工控机使用。若挪作其它用途将可能损坏接上的电器或者适配器。
 · 电源适配器所附的电源线为符合购买地的规格。若要在国外使用此工控机，请咨询经销商取得合适的电源线。
 · 若欲拨开电源适配器时，必须先拔掉墙壁上的电源插头，再拔掉插在工控机上的电源接头，否则会便工控机及适配器受到外部电压冲击而受损。
 · 拔掉插头时，请垂直 90° 插拔，切勿拉扯电线，应用手握着插头拔出。

Notice:
 · The AC adapter is designed for use with your Industrial Panel PC only. Connecting the AC adapter to another device can damage the adapter.
 · The AC power cord supplied with your Industrial Panel PC is for use in the country where you purchased your Industrial Panel PC. If you plan to go overseas with the Industrial Panel PC, consult your dealer for the appropriate power cord.
 · When you disconnect the AC adapter, disconnect from the electrical outlet first and then from the Industrial Panel PC. A reverse procedure may damage the AC adapter or Industrial Panel PC.
 · When unplugging the connector, please plug in 90° vertically, always hold the plug head. Never pull on the cord.

由于您的工控机是以直流电运作，但是电源插座通常是提供交流电源，因此电源适配器的作用就是将供电来源的交流电转换为工控机所需的直流电。
 适配器可在 100V 至 240V AC 的电压范围内运作。
 The AC adapter serves as a converter from AC (Alternating Current) to DC (Direct Current) power because your Industrial Panel PC runs on DC power, but an electrical outlet usually provides AC power. It also charges the battery pack when connected to AC power.
 The adapter operates on any voltage in the range of 100-240V AC.

故障排除/TROUBLESHOOTING

设备问题可以是硬件、软件、或两者共同引起的。当您遇到问题时，它可能只是一个一般性问题，能够轻易就解决。
 本章告诉您在面临一般性问题时，该尝试什么方法来解决。

初步检查要项/PRELIMINARY CHECKLIST

当您遇到问题时，不妨先做下列的初步检查，也许在此阶段即可解决问题：
 · 试着找出问题的来源和类别。

- 确定您在设备开机之前已开启外设设备的电源。
- 如果外接的设备出现问题，请确认所有线路的连接是否正确而且牢固。
- 确定 BIOS 中的设置完全正确。
- 确定所有驱动程序已安装完成。
- 细观察实际的状况。屏幕上是否出现任何信息？指示灯的亮灯情形为何？当您必须寻求维修人员的帮忙时，您所提供的信息是越详尽越好。

如果按照本章中的说明进行操作后问题仍然存在，请与授权经销商联系以寻求帮助。

When you encounter a problem, you may wish to do the following preliminary checks first, maybe you can solve the problem at this stage:

- Try to identify the source and category of the problem.
- Make sure you have turned on the power of the peripheral device before turning on the device.
- If there is a problem with the external equipment, please confirm whether the connection of all lines is correct and firm.

Make sure the settings in the BIOS are completely correct and firm.

Equipment problems can be caused by hardware, software, or both. When you have a problem, When you Make notes of your observations. Does any message appear on the screen? What is the status of the indicators light? Detailed descriptions are useful to the service personnel when you need to consult one for assistance.

If any problem persists after you follow the instructions in this chapter, contact an authorized dealer for help.